

### 3.02.0304-说明书F6B-五国语言-册子-RALCAM-V2.0-2026-01-20

尺寸:210\*148mm,展开尺寸,照尺寸做货  
要求:封面底面200g铜版纸单面覆哑膜,  
内页80g双胶纸,采用无线胶装方式装订  
封面封底内页印内容,照顺序排版印刷

210mm

**PF** PEAK  
FORCE

For more language versions of the manual, please scan the QR code below to view/download.

Für weitere Sprachversionen des Handbuchs scannen Sie bitte den QR-Code unten, um sie anzuzeigen/herunterzuladen.

より多くの言語バージョンのマニュアルについては、下記のQRコードをスキャンして表示/ダウンロードしてください。

Для получения дополнительных языковых версий руководства, пожалуйста, отсканируйте QR-код ниже, чтобы просмотреть/скачать.

Para más versiones del manual en diferentes idiomas, escanea el código QR de abajo para ver/descargar.

Para mais versões do manual em diferentes idiomas, por favor, escaneie o código QR abaixo para ver/baixar.

يؤنثاللا زهرا جسم يچوي بييتكالا نم قةفلتختم تاغلب خسنلا نم دوزلم ادليوزنت/شرحل هاندا داغبالا

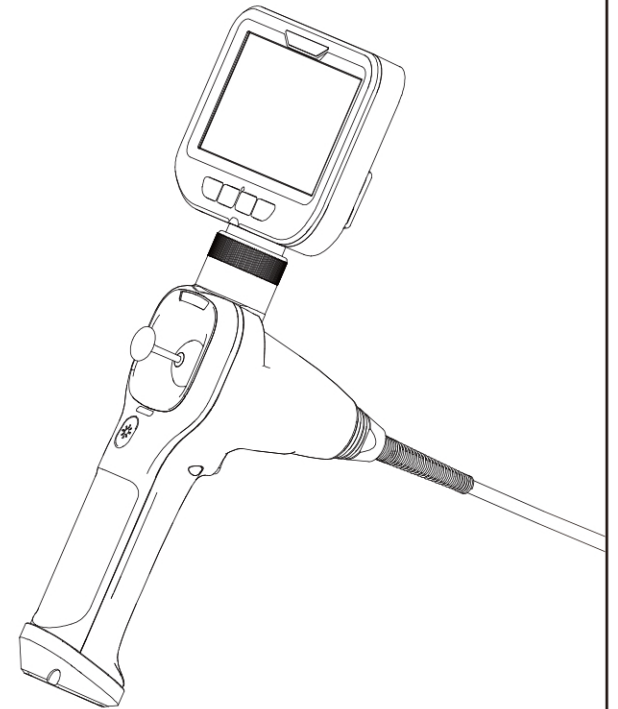

**F604B / F606B User Manual**

148mm

3mm

210mm

148mm

## ▶ PEAK FORCE

### Product Features

RALCAM is an innovative tool supplier established in 2010. We provide one-stop solution service of borescope for customers.

RALCAM-F6B Series is a Hot-selling Articulating Borescope. It's a must-have product and newly launched for global automotive aftermarket.

### Safety and Protection

- The camera probe is a high precision electronic device. Please do not touch the camera probe or pull the cable, which it may lead to device failure.
- The camera probe has an IP67 waterproof layer, and the body is not waterproof. When using the probe, be extra careful to prevent scratches!
- The camera probe is made of materials that are not resistant to high temperatures, so when checking any internal combustion engine or other equipment with high internal temperatures, please ensure that the internal temperature has cooled down, otherwise the equipment may be directly damaged!
- The exposed metal part of this product is made of conductive material. Please avoid contacting live circuits.
- If any equipment is damaged, please do not disassemble it by yourself. Please contact the seller or supplier for professional repair service.
- Without adult guidance, children cannot use the device independently.

### Operating and Storage environment

- The equipment should be operated at an ambient temperature of 22~118°F (-10~50°C).
- The equipment should be stored in a dry, clean, oil-free, water-free, and free of any chemical liquid environment.

### Warning

- Before using this product, please read the instructions carefully and follow them to avoid injury.
- Disassembly of this product is strictly prohibited, and we shall not be liable for any damage caused by unauthorized disassembly of this product.
- The main body of this product is not waterproof. Please avoid contact with liquids.
- Do not over-bend the camera probe. The bending limit of the snake tube is one cycle.
- Do not twist or pull the camera probe at the front of the snake tube.
- Before pulling out the snake tube, make sure the steering wheel is back to the centered position, and do not turn the steering wheel violently.







1

BORESCOPE

EN

## ▶ PEAK FORCE

### Product Introduction

- 1**  **Power Button**  
Press the power button for about 3 seconds to turn on the power. When the power is on, the camera will automatically enter camera mode.
- 2**  **LED Light Button**  
Press the button to adjust the brightness. The brightness has 3 levels, and the fourth level is to turn off the LED light.
- 3**  **Menu/Settings Button**  
In the preview interface, press to enter the menu. Long-press the button for about 3 seconds to enter the album, and long-press again for about 3 seconds to exit the album. Press the button in the album interface to display the menu interface, where you can delete, protect photos/videos, and play photo slideshows.
- 4**  **Up/Zoom in Button**  
Press in the preview interface to zoom in on the displayed image. Press in the menu interface to move the cursor up.
- 5**  **Down/Rotate Button**  
In preview: tap to rotate the preview image; in the menu: tap to move the cursor down.
- 6**  **Photo/Record Button**  
Located on the back of the device, below the snake tube. Press to take a photo, long-press to record video, and press to end recording and return to the preview interface.
- 7**  **Confirm Button**  
In the preview interface, press to take a photo. Hold for 2 seconds to start recording video, press again to stop recording video and return to photo mode. Press in the menu interface to confirm selection.
- 8** **Charging Indicator Light**  
The blue indicator light turns on when the device is powered on. The red LED stays on when charging, and the green LED stays on when fully charged.
- 9** **TF Card Slot**  
Supports up to 32GB TF card storage. Please format the TF card before first use.
- 10** **Type-C Charging Port**  
Used for charging (Type-C cable connected to the adapter). Used for data transfer (Type-C cable connected to PC client).
- 11** **Control Joystick**  
Slide the control joystick to change the camera angle accordingly.

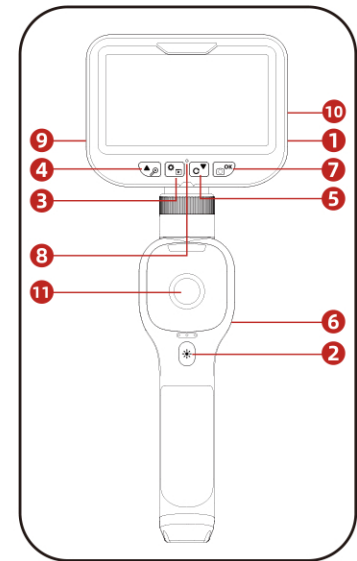

EN

BORESCOPE

2

3mm

210mm

148mm

## ▶ PEAK FORCE

English

### Icon Introduction

#### Preview Interface

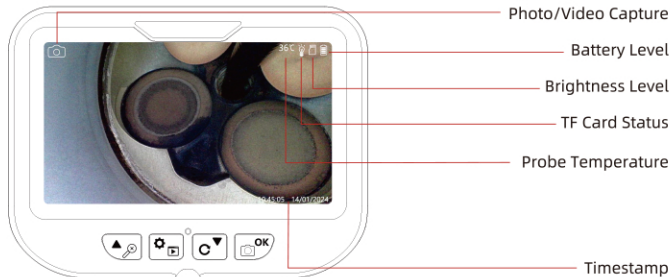

#### Note:

If either the operating temperature of the camera probe or the ambient temperature reaches 90°C, the device will automatically shut down due to overheating protection. Additionally, only the camera probe part is waterproof.

#### Album Interface

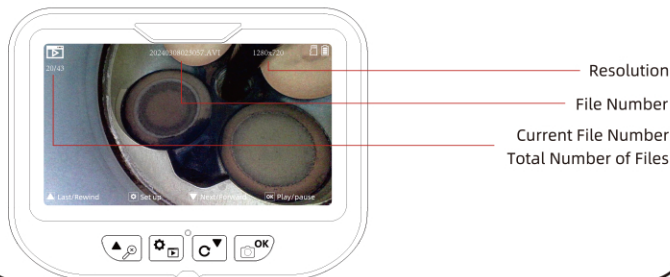

3

BORESCOPE

EN

## ▶ PEAK FORCE

English

### OSD Settings

#### Language Setting

1. Press the (Settings) button to display the election menu.
2. Use the / buttons to select the menu item "Language" as the first item in the menu.
3. Press the button to confirm the selection.
4. Press the button to return to the image preview interface.



#### Viewing Photos/Videos

1. In the preview interface, long-press the button for 2 seconds to enter the album.
2. Press the / buttons to view photos or videos, press the button to play/pause the video, long-press the / buttons to fast forward or rewind the video.
3. Long-press the button to return to the preview level and exit the album.

#### Photo shooting/video recording

1. In the preview interface, press the button/the photo recording button under the snake pipe to take a photo.
2. Hold for 2 seconds to start recording video, press again to stop recording video.

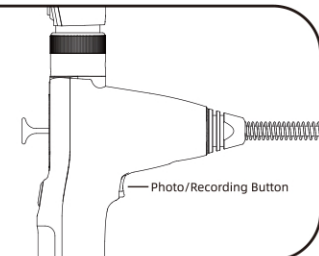

EN

BORESCOPE

4

3mm

210mm

148mm

## ▶ PEAK FORCE

English

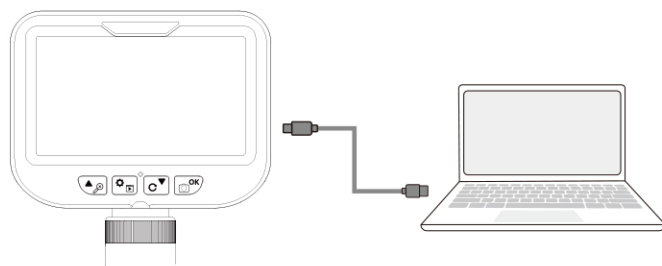

### Copying Photos/Videos to the Computer

1. Connect to your computer with the included Type-C cable.
2. Find the USB flash drive in "My Computer" and copy the required files to your computer.

### Package Contents

F6-B	Type-C Charging Cable	User Manual

5

BORESCOPE

EN

## ▶ PEAK FORCE

English

### Specification

Specification		Model	
		F604B	F606B
Display	Screen	4.3"IPS	
	Menu language	Chinese Simplified, Chinese Traditional, Japanese, English, Korean, French, Russian, Spanish, German	
	Function(Photos/Recording/ Playback/Image rotation)	√	
	TF Card	√	
	Real-time temperature	√	
Camera & Probe	Camera resolution	1280*720p	
	Steering radius	Approximately 25mm	Approximately 30mm
	Steering angle	Four-way 360°	
	Steering life	≥20000 times	
	Semi rigid / Flexible customizable	√	
	Snake tube length	1M/2M/3M/Custmizable	
	Lens diameter	Φ3.9mm	Φ6.2mm
	FOV	100°	90°
	DOF	8-100mm	15-100mm
	Adjuster LED light	High Lumen LED Beads	
Package	Waterproof	IP67	
	High temperature protection over 90°C will shutdown automaticaly	√	
Box size	34.5*28*9cm		
	58*47*37.5cm		
Operating Environment	Battery Charging	DC5V*2A; 3.7V; 16.3Wh	
	Working time	About 6 Hours	
	Temperature & relative humidity	-10°C~ 50°C; Less than 90%	
Certification	CE; FCC; ROHS; Patent		
	√		

EN

BORESCOPE

6

3mm

210mm

148mm

## ▶ PEAK FORCE

### 产品特点

RALCAM 是一家创新的工具供应商，成立于2010年。我们可以为客户提供全方位的内窥镜解决方案服务。RALCAM-F6-B 系列是一款热销的转向内窥镜。它是一款汽修必备产品，专为全球汽车售后市场新推出的。

### 安全与保护

- 摄像头探头是一种高精度的电子设备。请勿触摸摄像头探头或拉动电缆，这可能导致设备故障。
- 摄像头探头具有 IP67 防水层，机身不防水。使用探头时，请格外小心，以防划伤！
- 摄像头探头由不耐高温的材料制成，因此在检查任何内燃机或其他具有高内部温度的设备时，请确保内部温度已冷却，否则设备可能直接损坏！
- 本产品的外露金属部分由导电材料制成。请避免接触带电电路。
- 如果设备损坏，请勿自行拆卸。请联系卖方或供应商进行专业维修服务。
- 未经成年人指导，儿童不能独立使用该设备。

### 操作和存储环境

- 该设备应在环境温度为 22-118°F (-10-50°C) 的条件下操作。
- 该设备应存放在干燥、清洁、无油、无水、无任何化学液体的环境中。

### 警告

- 使用本产品前，请仔细阅读说明并遵循，以避免受伤。
- 严禁拆卸本产品，我们不对未经授权拆卸造成的任何损坏负责。
- 本产品主体不防水。请避免接触液体。
- 不要过度弯曲摄像头探头。蛇形管的弯曲极限为一个周期。
- 不要在蛇形管前端扭曲或拉动摄像头探头。
- 在拉出蛇形管之前，请确保操作摇杆已回到中心位置，并且不要剧烈转动操作摇杆。

1

BORESCOPE

CN

## ▶ PEAK FORCE

### 产品介绍

- 1 电源按钮**  
位于屏幕右侧，按下电源按钮约 3 秒钟以打开电源。当电源打开时，摄像头将自动进入相机模式。
- 2 LED 灯按钮**  
点按按钮可调节亮度，亮度分为 3 个级别，第4个级别是关闭 LED 灯。
- 3 菜单/设置按钮**  
在预览界面中，点按进入菜单。长按按钮约 3 秒钟以进入相册，再长按按钮约 3 秒钟以退出相册。在相册界面中点按显示菜单界面，可以删除、保护图片/视频，播放图片幻灯片。
- 4 上按钮**  
在预览界面中点按可放大2倍画面，再次点按则放大4倍，第三次点按则会回到原画面大小，在菜单界面中点按以向上移动光标。
- 5 下/旋转按钮**  
在预览界面中点击可将实时图像旋转；在菜单界面中点击可向下移动光标。
- 6 拍照录像按钮**  
位于设备背面，蛇管下方。点按拍照，长按录视频，点按结束录制，返回预览界面。
- 7 OK 确认OK按钮/拍照按钮**  
在预览界面，点按以拍照。按住 2 秒以开始录制视频，再次点按以结束录制视频，回到拍照模式。在菜单界面中点按以确认选择。
- 8 充电指示灯**  
蓝色指示灯开机即亮，充电时红色 LED 常亮，充满电时绿色 LED 常亮。
- 9 TF 卡插槽**  
支持最大 32GB 的 TF 卡存储。首次使用前，请格式化 TF 卡。
- 10 Type-C 充电端口**  
用于充电（Type-C 线连接到适配器）。用于数据传输（Type-C 线连接到 PC 客户端）。
- 11 操作摇杆**  
滑动控制摇杆，相机角度相应变化。

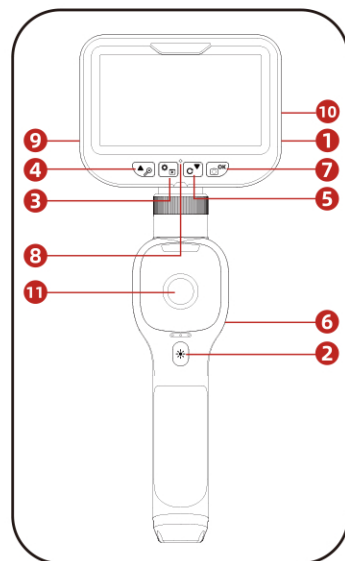

CN

BORESCOPE

2

3mm

210mm

148mm

## ▶ PEAK FORCE

### 图标介绍

#### 预览界面

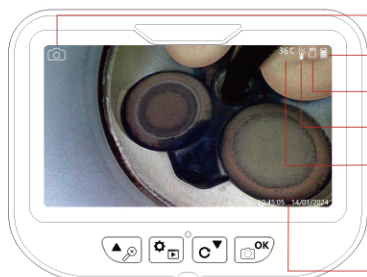

拍照/录像

电池电量

亮度级别

TF 卡状态

探头温度

时间戳

#### 注意:

无论是摄像头探头的工作温度还是环境温度达到 90°C，设备都会因高温保护而自动关闭。并且只有摄像头探头部分是防水的。

#### 相册界面



分辨率

文件编号/照片名称

当前文件序号/文件总数

## ▶ PEAK FORCE

### OSD 设置

#### 语言设置

1. 按下 (设置) 按钮，将显示选择菜单。
2. 使用 / 按钮选择菜单项“语言”为菜单第一项。
3. 按下 按钮确认选择。
4. 按下 按钮返回到图像预览界面。



#### 查看照片/视频

1. 在预览界面，长按 按钮 2 秒进入相册。
2. 点按 / 按钮查看照片或视频，点按 按钮播放/暂停视频，长按 / 按钮快进或快退视频。
3. 长按 按钮退出相册并返回到预览界面。

#### 拍照/录像

1. 在预览界面，点按 或蛇管下方的拍照录制键拍照。
2. 按住 2 秒开始录制视频，再次点按结束录制视频。

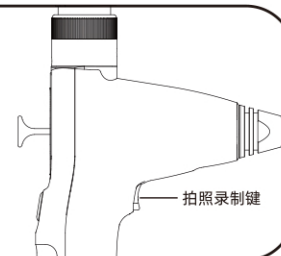

3mm

210mm

148mm

## PEAK FORCE

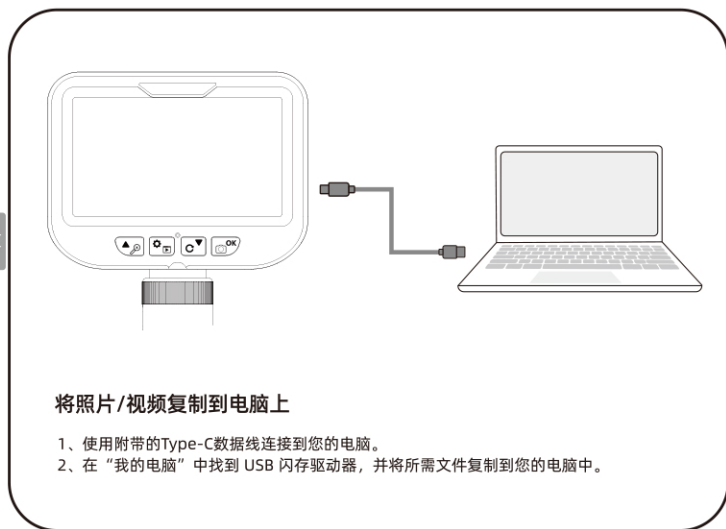

## 将照片/视频复制到电脑上

- 1、使用附带的Type-C数据线连接到您的电脑。
- 2、在“我的电脑”中找到USB闪存驱动器，并将所需文件复制到您的电脑中。

## 包装清单

F6-B	Type-C 充电线	用户手册

5

BORESCOPE

CN

## PEAK FORCE

## 规格参数

规格	型号		
	F604B	F606B	
显示	屏幕	4.3"IPS	
	菜单语言	简体中文, 繁体中文, 日语, 英语, 韩语, 法语, 俄语, 西班牙语, 德语	
	功能 (照片/录制/回放/图像旋转)	√	
	TF卡 (最大32G)	√	
	实时温度	√	
摄像头和探头	摄像头分辨率	1280*720p	
	转向半径	约25mm	约30mm
	转向角度	四向360°	
	转向寿命	≥20000次	
	半刚性/柔性可定制	√	
	蛇管长度	1M/2M/3M/可定制	
	镜头直径	Φ3.9mm	Φ6.2mm
	视场角(FOV)	100°	90°
	景深(DOF)	8-100mm	15-100mm
	可调LED灯	高流明LED灯珠	
防水	IP67		
高温保护超过90°C会自动关闭	√		
包装	盒子尺寸	34.5*28*9cm	
	纸箱尺寸	58*47*37.5cm	
操作环境	电池充电	DC5V*2A; 3.7V; 16.3Wh	
	工作时间	大约6小时	
	温度和相对湿度	-10°C~50°C; 小于90%	
认证	CE; FCC; ROHS; 专利	√	

CN

BORESCOPE

6